



Technical Data Sheet

A-PED-57-82

Adjustable from 57 to 82mm

COMPONENTS

A-PED-57-82 is composed of:

- 1 x A-PED Head
- 1 x A-PED Base
- 1 x TP-1 Turning Plate
- 1 x 50mm Rod
- 2 x Locking Nuts

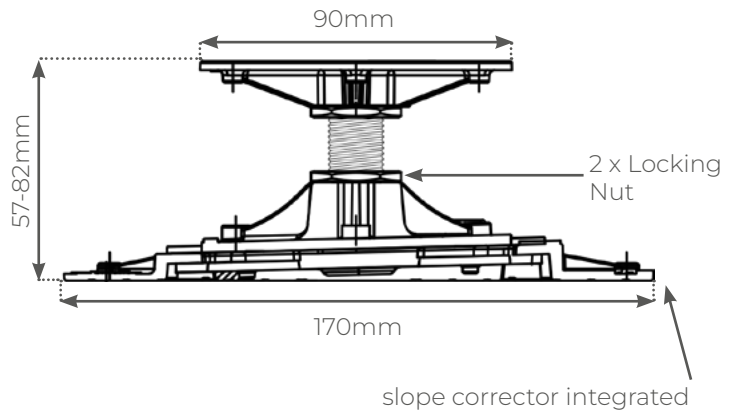

CHARACTERISTICS

Head: \varnothing 90mm

Base: \varnothing 170mm

Weight: 0.413Kg

Height adjustable from 57-82mm

Slope Corrector: Is integrated in base of the pedestal, providing slope correction from 0-5%

Fire-Rating: **Class A1** according to BS EN 13501-1

MATERIAL

Designed and Manufactured in Europe

A-PED-HEAD, A-PED-BASE, TP1: **Aluminium**

Threaded Rod: **M16 zinc plated steel**

Locking Nuts: **Steel with exterior coating**

Resistant to weathering, sea salts and a wide range of chemicals.

COMPRESSION TEST

Load testing has been performed on the range of A-PED pedestals to 6 tons and we will certify to + 3 tons per pedestal.

For more information, please contact info@buzonuk.com

APPLICATION

Non-combustible adjustable pedestal, ideal for any hard landscaping or external flooring project including high-rise balconies requiring a Class A fire-rating.

Suitable for sites where the void is minimal, the pedestal can be used in conjunction with the 170mm Spreader Plate accessory in situations where a wider base is required.

The A-PED range has a suite of Class A fire-rated accessories:

- Spacer Tabs
- Edging
- Joists
- Shims (Class B-rated)
- Membrane Protection (Class A & B-rated versions)

Spacer Tabs



A-PED-TABS-RING-3MM
Thickness: 3mm
Height: 11mm

Locking Key



A-PED-Key



A-PED-TABS-5MM
Thickness: 5mm
Height: 13mm

Edging



A-PED-WALL
Edge Restraint

Joists



A-PED-JOIST-20
Height: 20mm

PACKAGING

Packaging	Head	TP1	Base	50mm Rod	Nut x 2	Unit
Product per Box	120	120	60	60		items
Unit Weight	0.082	0.082	0.178	0.065	0.003	kg
Box Weight	9.84	9.84	10.68	3.9		kg
Box Dimension	395x290x200	395x290x200	395x290x200			mm
Boxes per Pallet	48	48	48			qty
Product per Pallet	5,760	5,760	2,880			items
Pallet Dimension	80x120	80x120	80x120			cm

SAFETY INSTRUCTIONS

Buzon pedestals are designed to support external raised floors for pedestrian traffic only and are not designed to support or be subjected to moving and/or vibrating machinery & equipment, including maintenance, cleaning vehicles, automobiles and other similar equipment.

Contact us if you require further technical support or advice

buzonuk.com - info@buzonuk.com - +44 (0)20 8614 0874



Buzon has a policy of continuous improvement and reserves the right to modify, revise or change the above specifications without notice. This brochure is for descriptive purpose only and is based on the product as on the date of publication of this information.